

Aufstellsituation CL1E/ installation situation CL1E

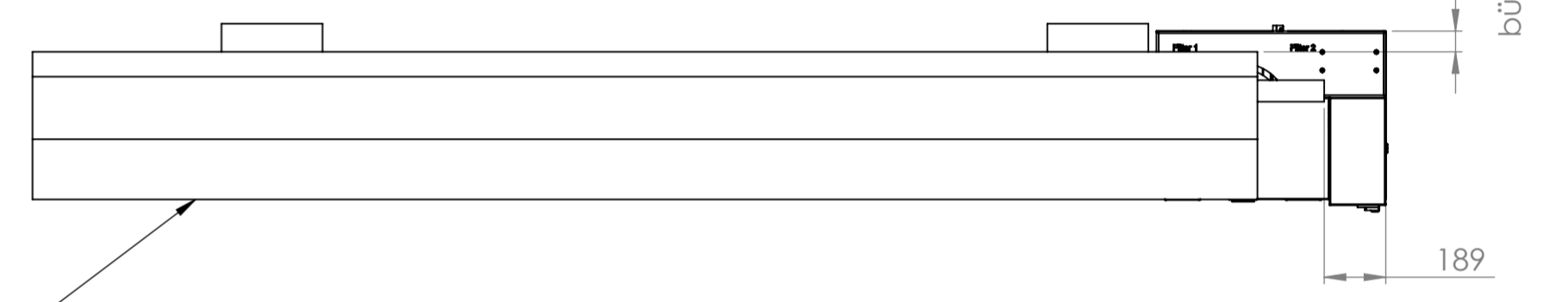

Bedienerseite/
operator side

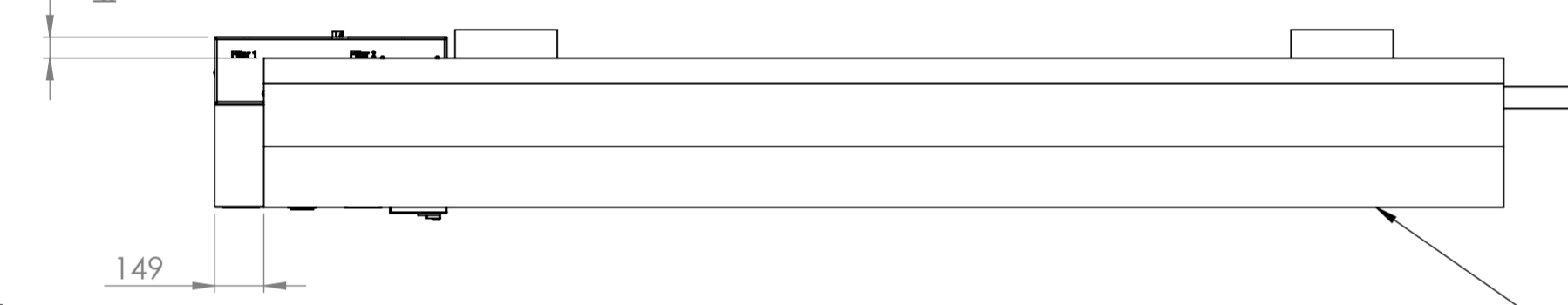
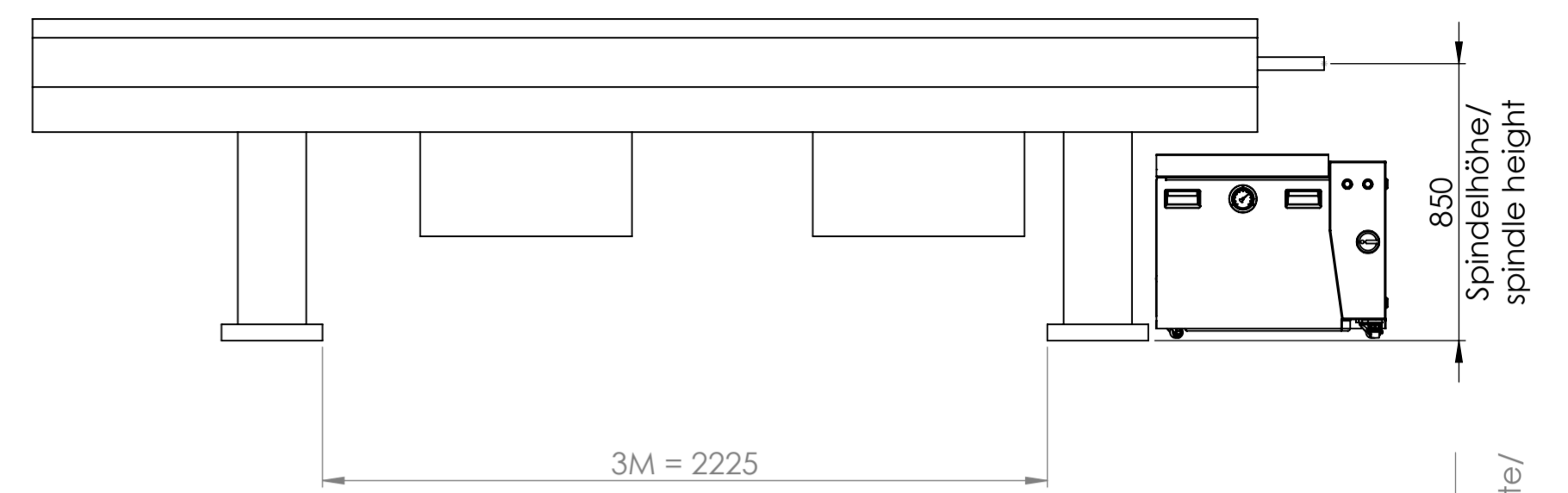
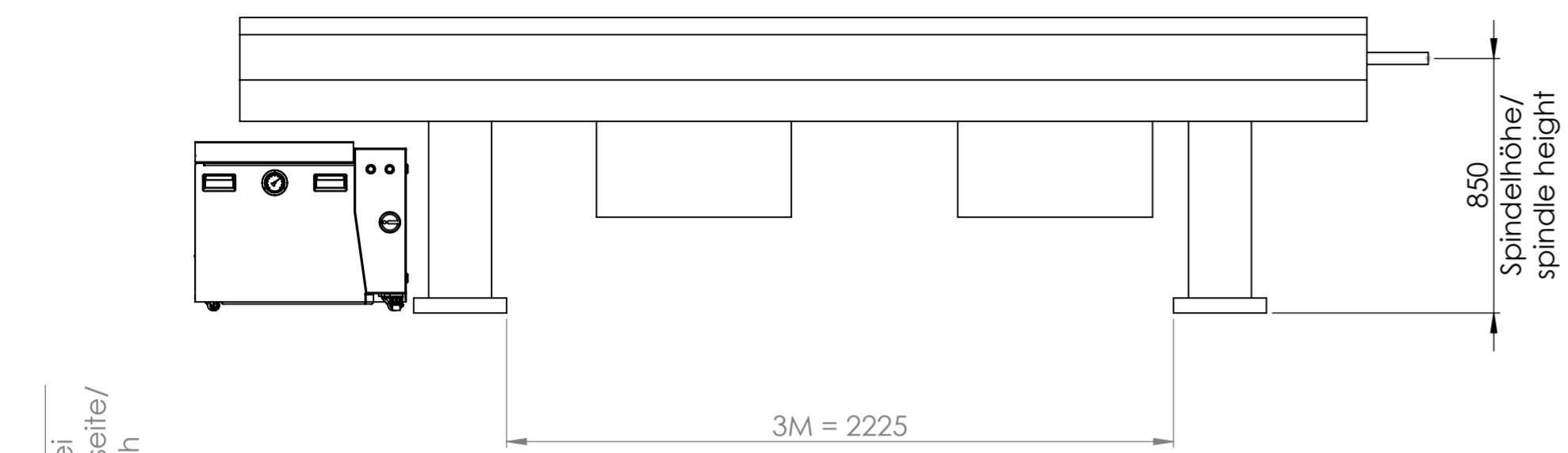
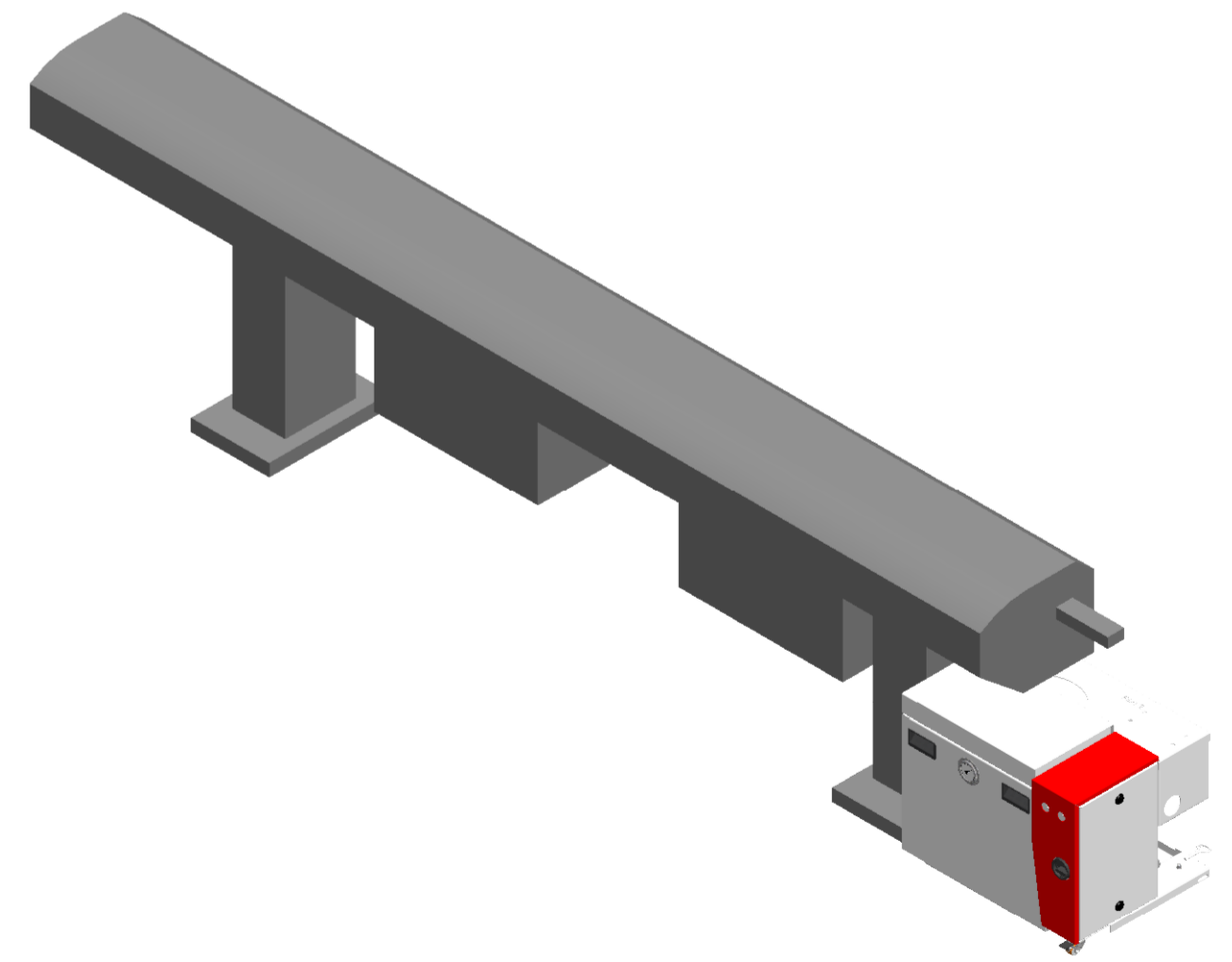
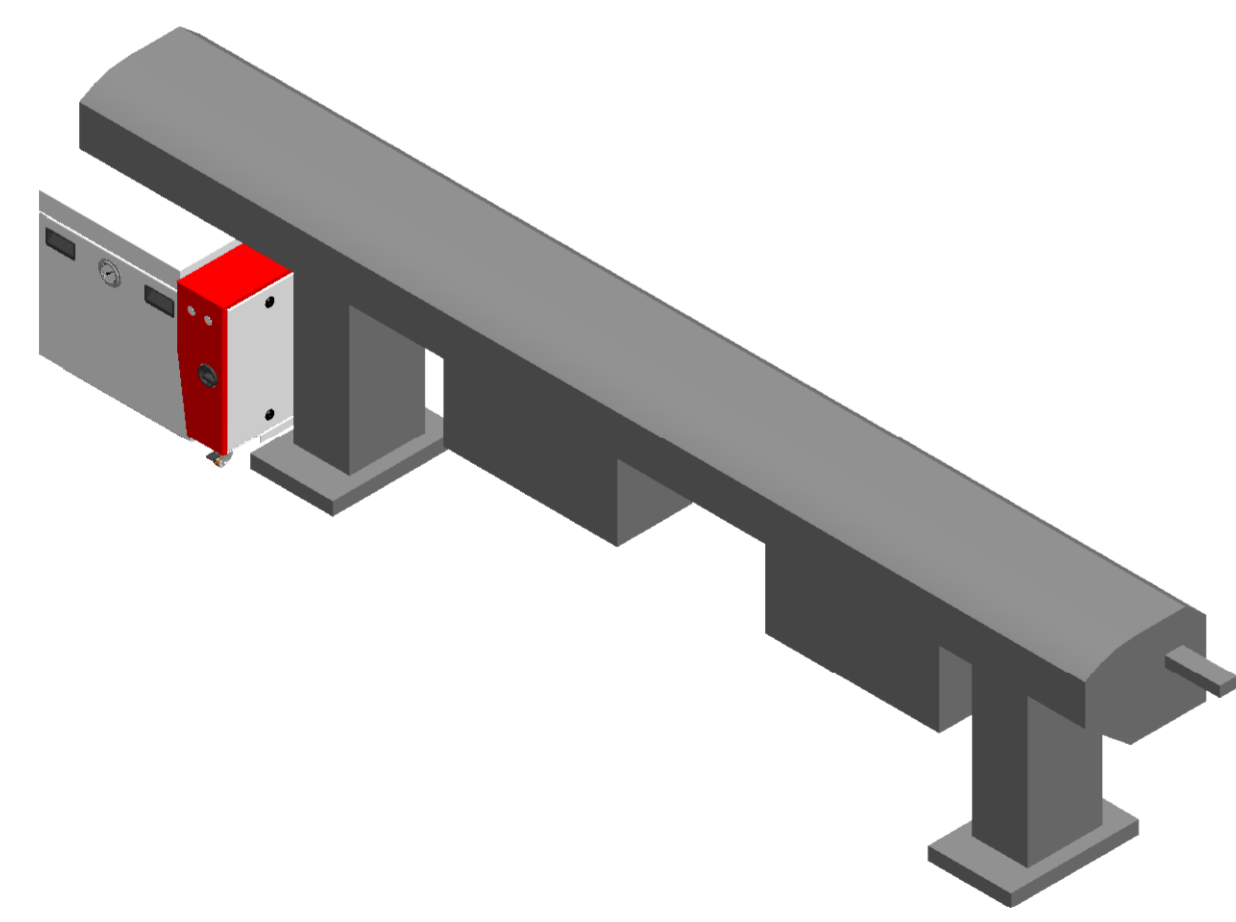

Diese Zeichnung ist urheberrechtlich geschützt und darf ohne die schriftliche Zustimmung der Firma Müller Hydraulik GmbH keinen Dritten inhaltlich mitgeteilt noch ausgehandelt werden!
This drawing is copyrighted and may not be handed over to third parties without written approval of the company Müller Hydraulik GmbH concerning the contents!

Allgemeintoleranzen/ General tolerances DIN ISO 2768-mK		Datum Name	
Erstellt	27.03.2020	Freig.	trupp
Zust.	Änderungen/Changes	Datum	Name

Müller Hydraulik GmbH
Albring 29
78658 Zimmern o. R.
Tel.: 0741-174575-0

Halbzeug/Raw material:		ERP-Artikel:	
Werkstoff/Material:		Benennung/Title:	
Gewicht/Weight:		Aufstellsituation_Express_112_3M	
Zeichnungsnummer/Drawing number:		Status in Arbeit	Format A2
20-03-34725		Version	Blatt/Sheet 1 / 3
Maßstab/Scale: 1:20			

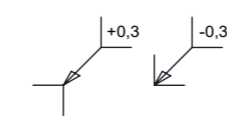

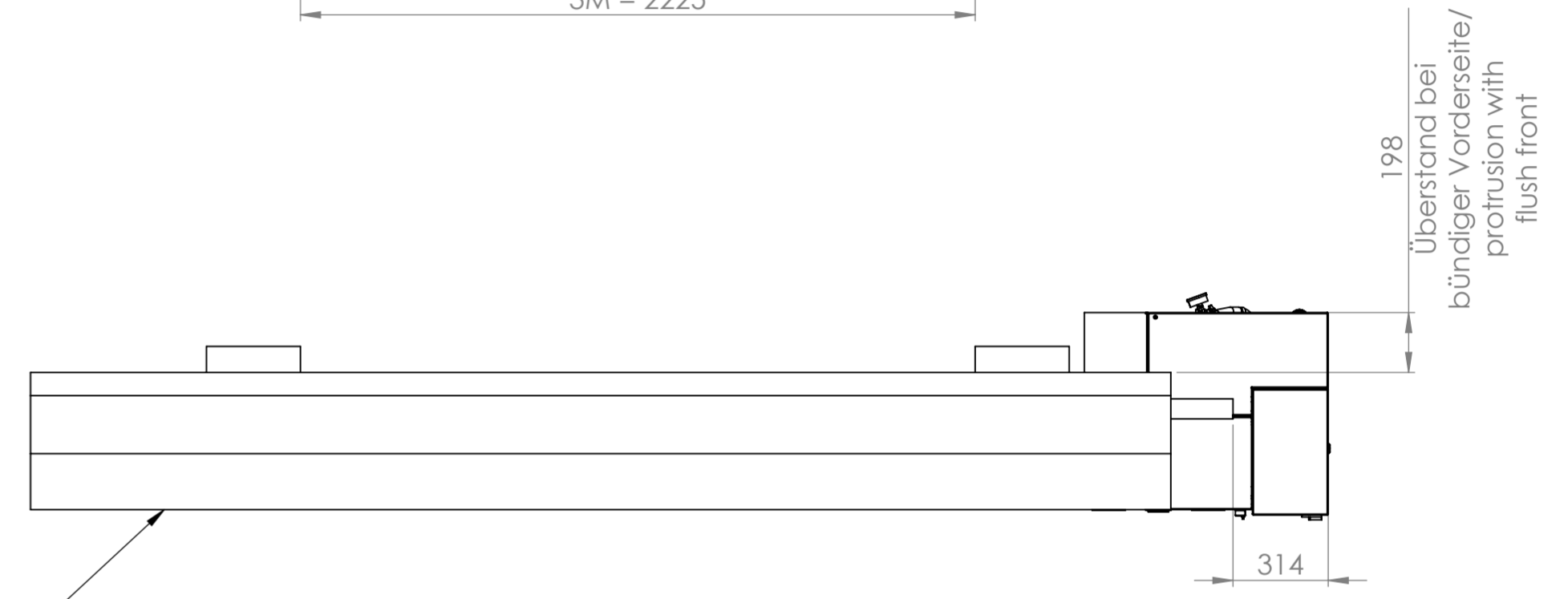
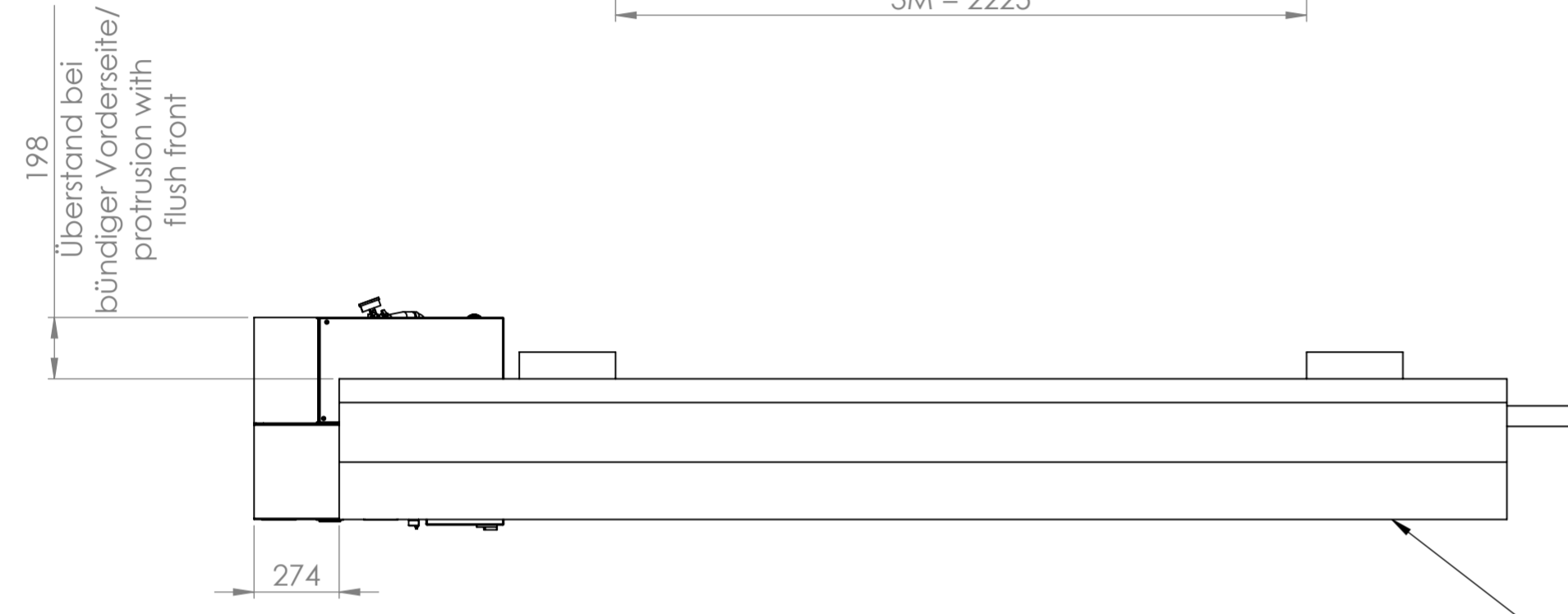
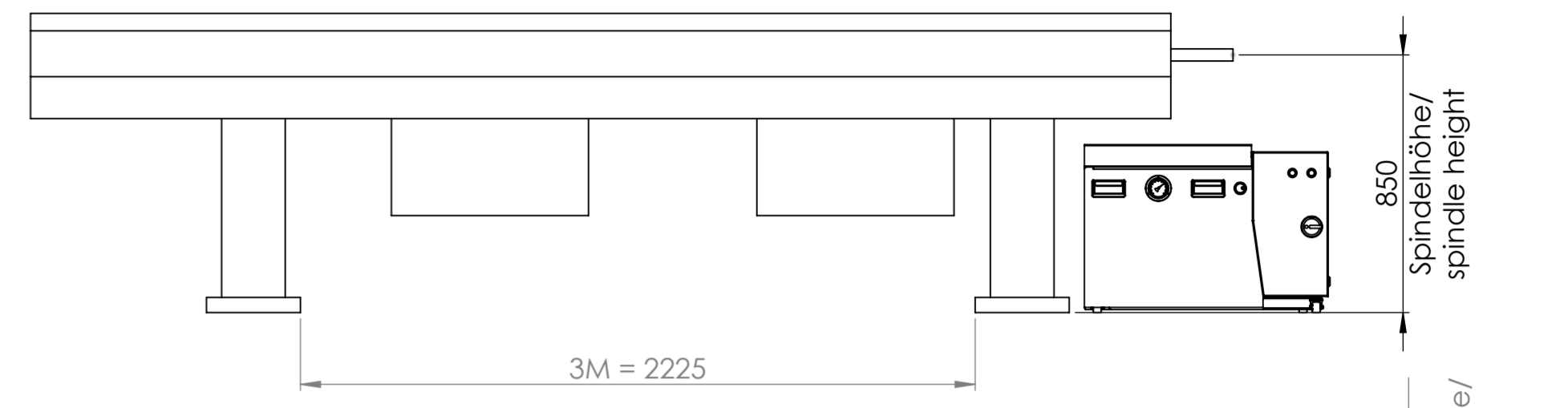
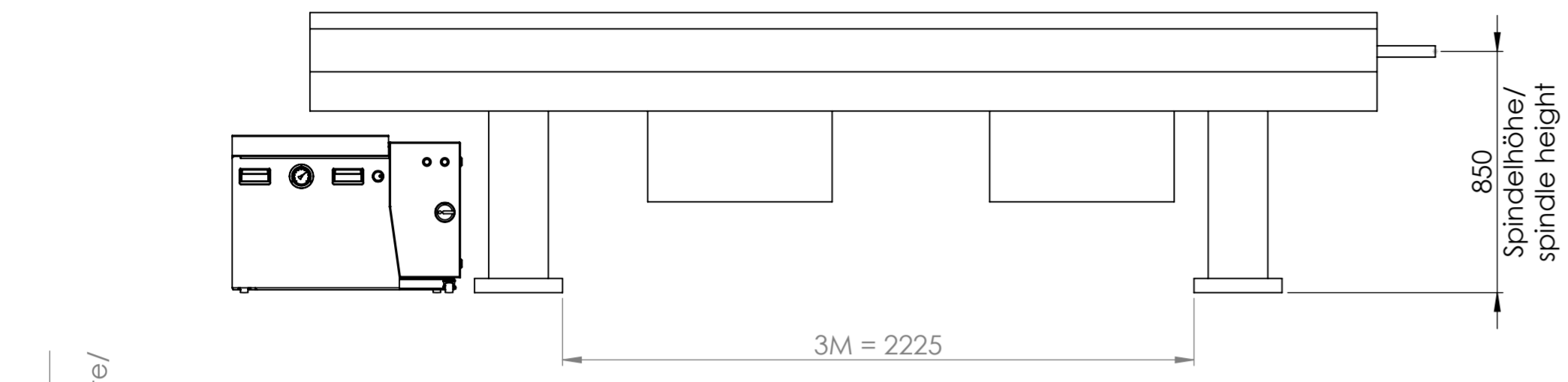

Bedienerseite/
operator side

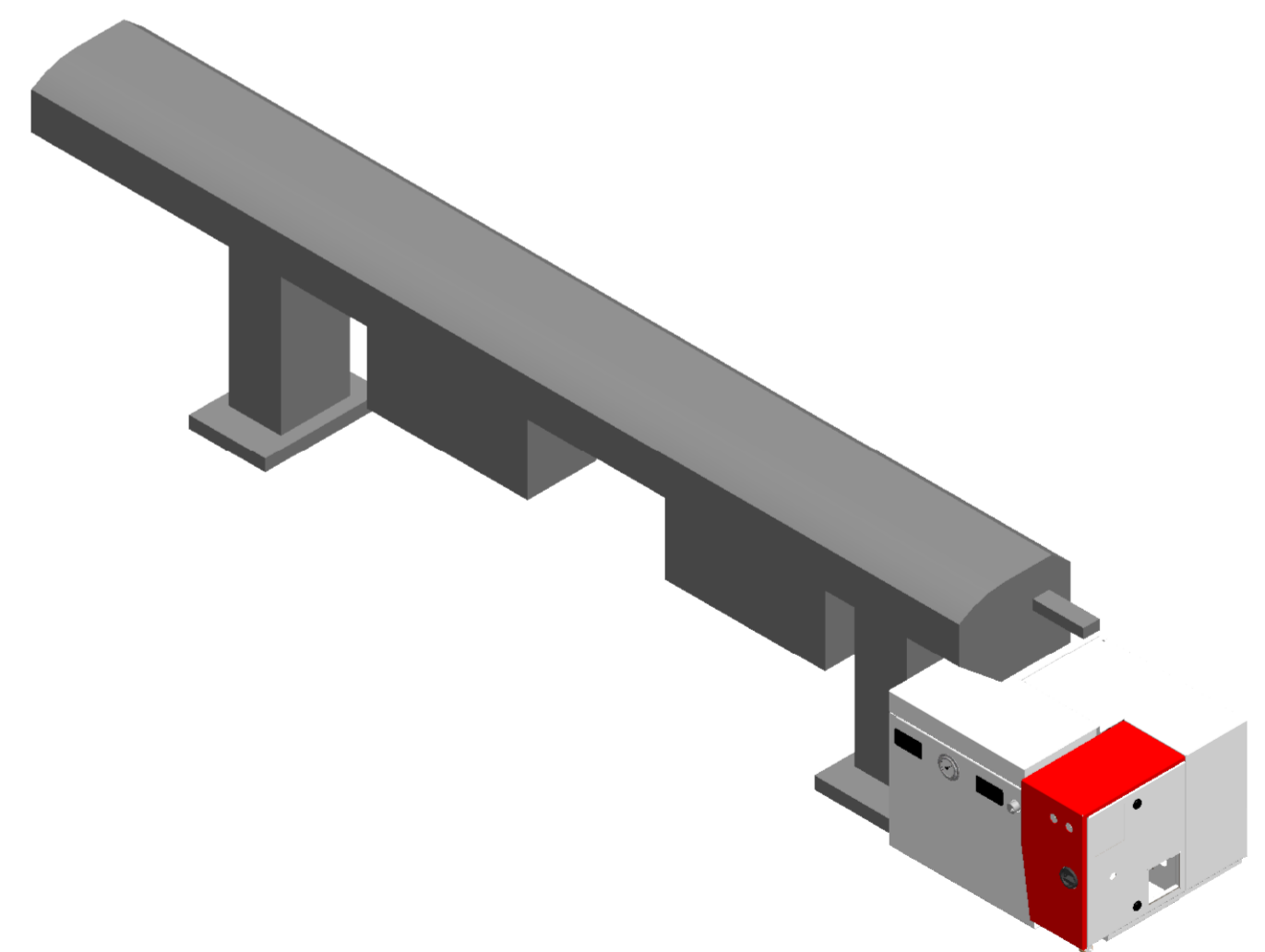
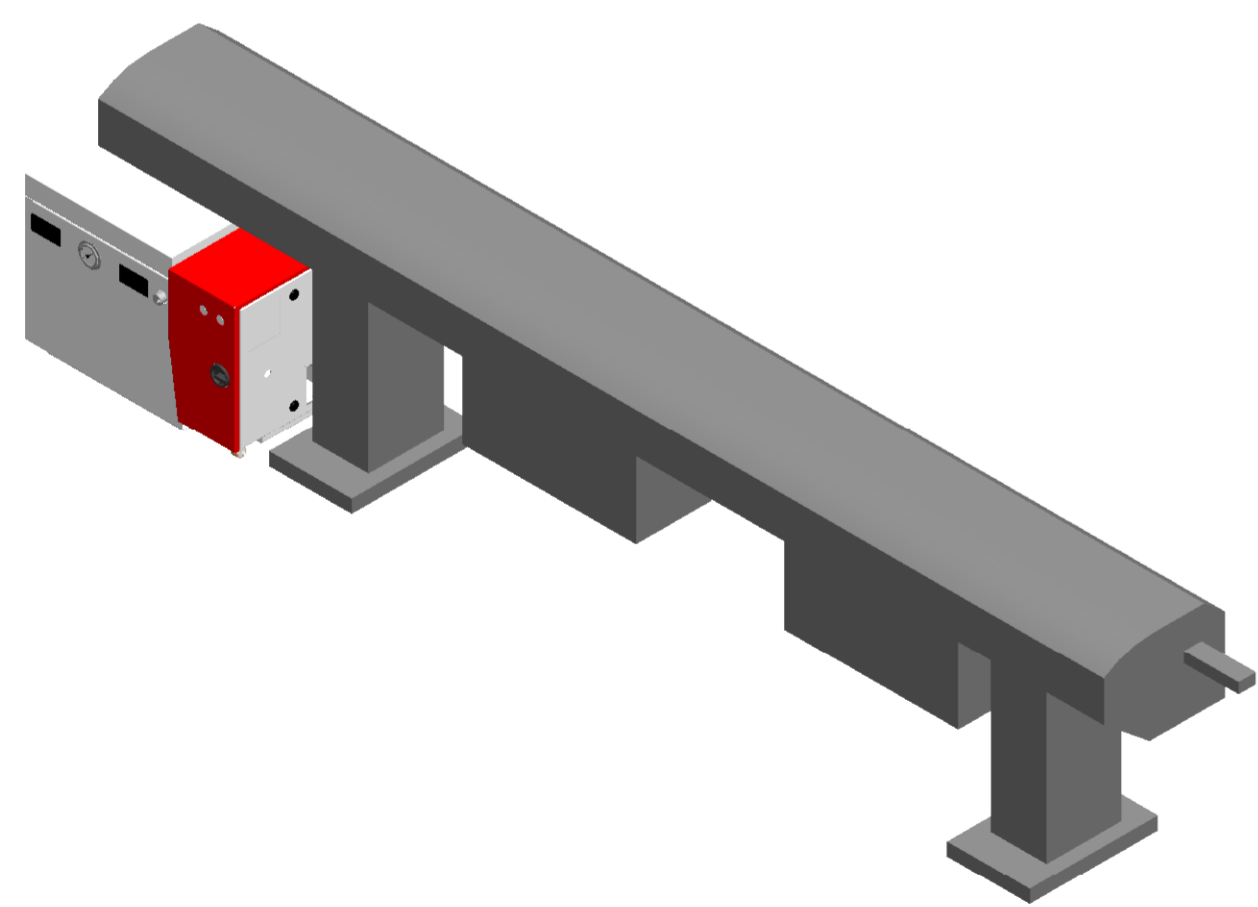

Aufstellsituation CL2E/ installation situation CL2E



Diese Zeichnung ist urheberrechtlich geschützt und darf ohne die schriftliche Zustimmung der Firma Müller Hydraulik GmbH keinen Dritten inhaltlich mitgeteilt noch ausgehandelt werden!
This drawing is copyrighted and may not be handed over to third parties without written approval of the company Müller Hydraulik GmbH concerning the contents!

Zust.	Änderungen/Changes	Datum	Name

Allgemeintoleranzen/ General tolerances DIN ISO 2768-mK		Datum 27.03.2020	
Erstellt Freig.		Name trupp	
Müller Hydraulik GmbH Albring 29 78658 Zimmern o. R. Tel.: 0741-174575-0			

Halbzeug/Raw material:		ERP-Artikel:	
Werkstoff/Material:		Benennung/Title:	
Gewicht/Weight:		Aufstellsituation_Express_112_3M	
Zeichnungsnummer/Drawing number:		Status in Arbeit	Format A2
20-03-34725		Version	Blatt/Sheet 2 / 3
Maßstab/Scale: 1:20			

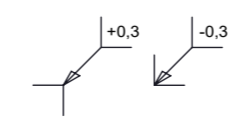

- W = ✓
- Y = √Rz100
- V = √Rz25
- Z = √Rz6.3

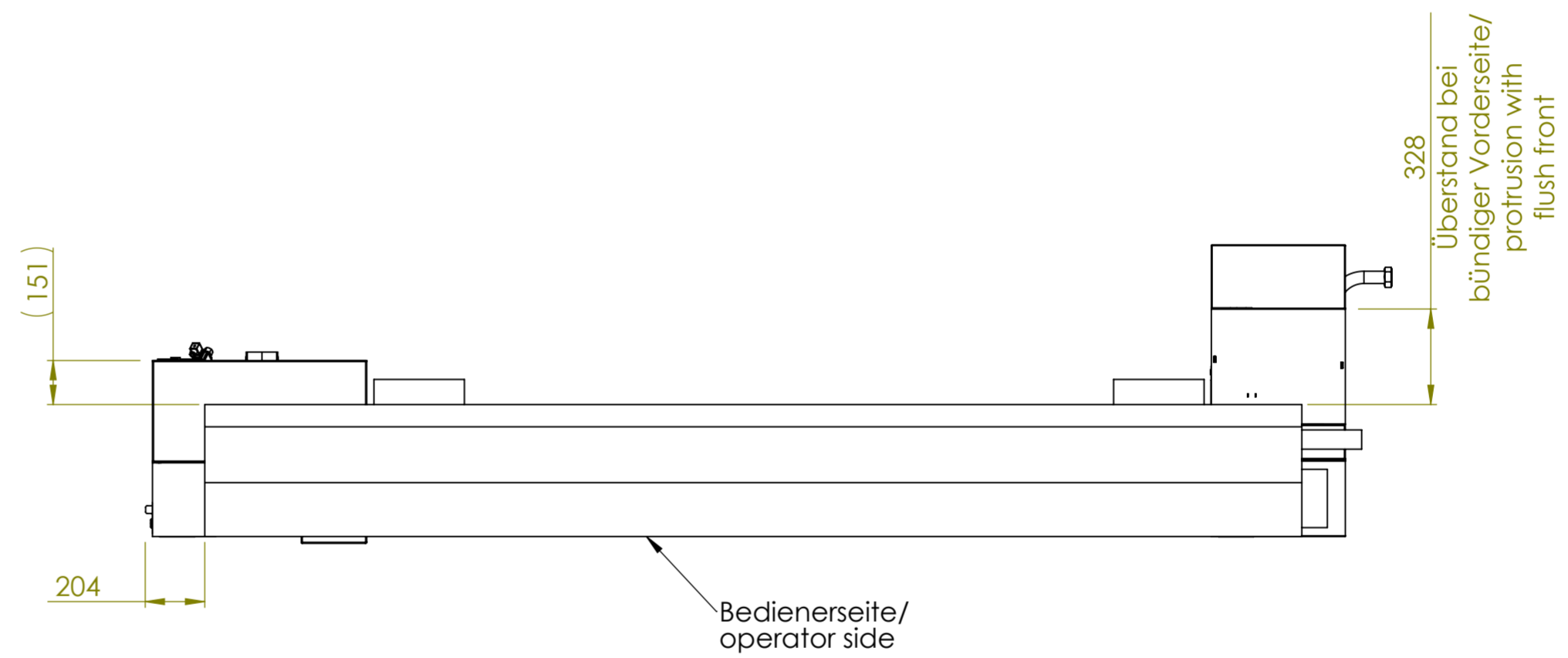
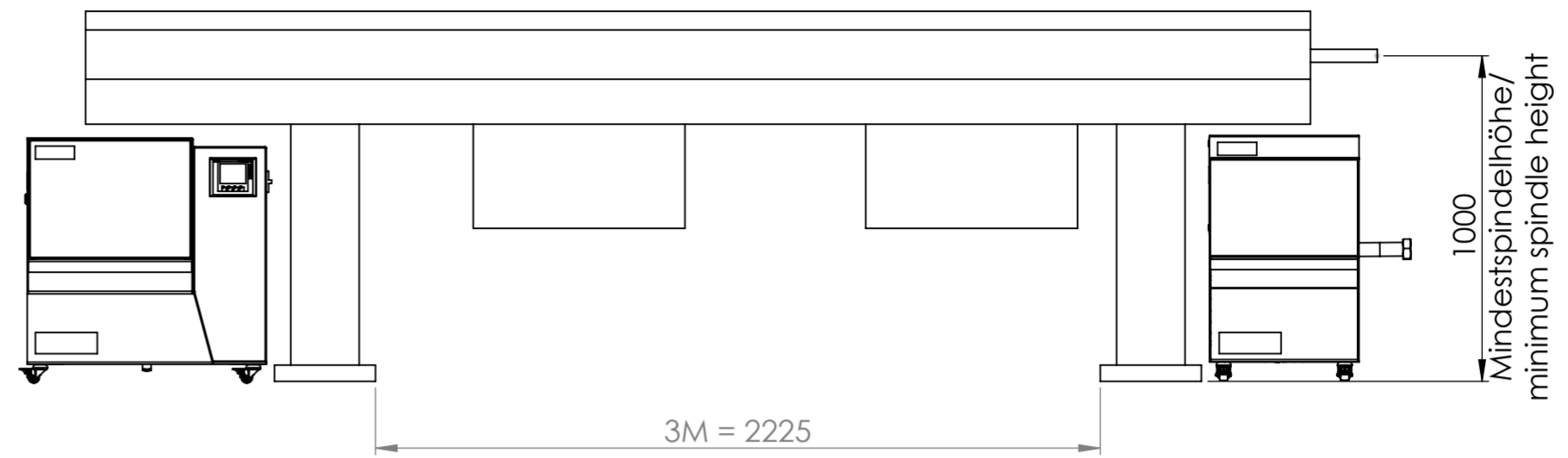
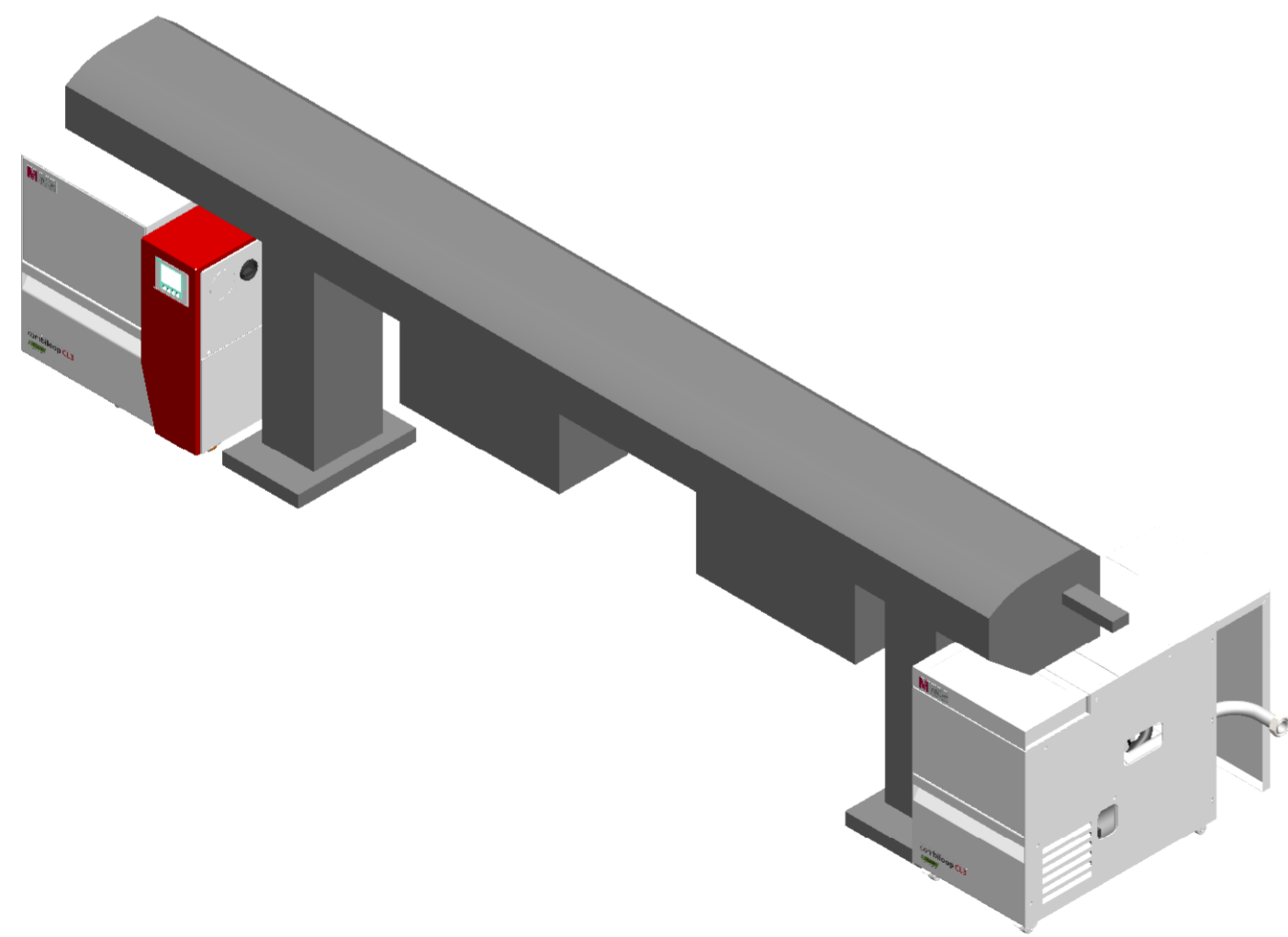

Aufstellungssituation CL3E/ installation situation CL3E



Diese Zeichnung ist urheberrechtlich geschützt und darf ohne die schriftliche Zustimmung der Firma Müller Hydraulik GmbH keinen Dritten inhaltlich mitgeteilt noch ausgehandelt werden!
This drawing is copyrighted and may not be handed over to third parties without written approval of the company Müller Hydraulik GmbH concerning the contents!

Allgemeintoleranzen/
General tolerances
DIN ISO 2768-mK

DIN 6 T1 -
Proj.methode 1

Halbzeug/Raw material:

Werkstoff/Material:

Gewicht/Weight: ERP-Artikel:

Benennung/Title:

Aufstellungssituation_Express_112_3M

Zeichnungsnummer/Drawing number:

20-03-34725

Status

in Arbeit

Version

Format

A2

Blatt/Sheet

3 / 3

Müller Hydraulik GmbH
Albring 29
78658 Zimmern o. R.
Tel.: 0741-174575-0

Erstellt		Datum	
Freig.		27.03.2020	
Name		Datum	
trupp			
Zust.		Änderungen/Changes	
Datum		Name	

